

Data Sheet



Article number: 03802016C

Description: Fluro rod end
GKAW 16 ICR

Measures

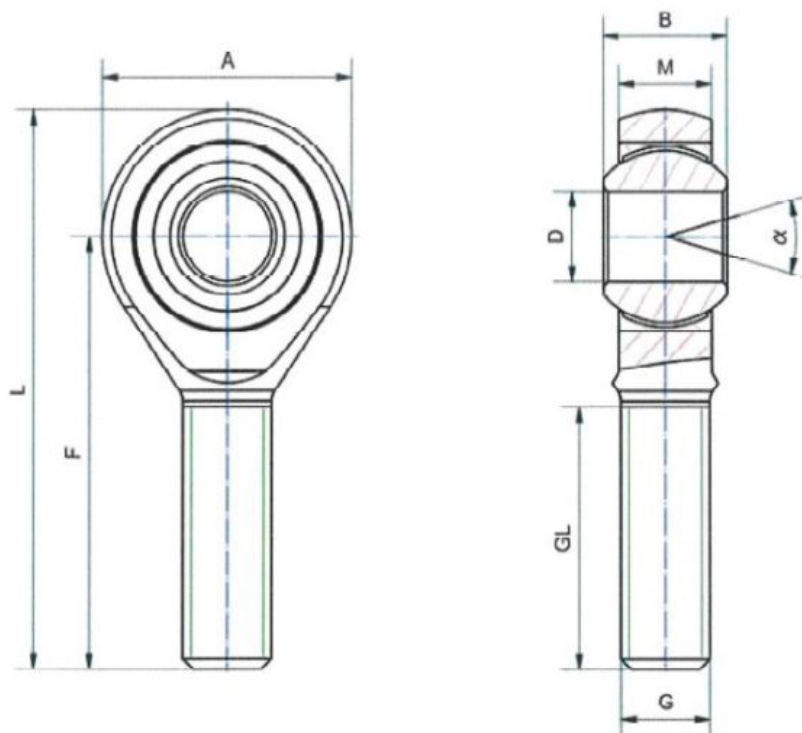

A = 42
B = 21
F = 66
G = M16
GL = 37
L = 87
M = 15
O = 19.3